

auto electrical parts

Technical Information Sheet

Part No. 0-443-31

LED Beacon Light Bar, Amber, 12/24v, 4 Bolt Mount, 19 Flash Patterns, 40 x 1W LED's with 4D reflectors for maximum lumen output, 40W Max Power. IP65. 0.5M Flying Leads, E Marked R65, R10 EMC.



Additional Information

Wire Function

Red = +VE

Black = -VE

Yellow = Flash Pattern

Technical Drawing (not to scale)

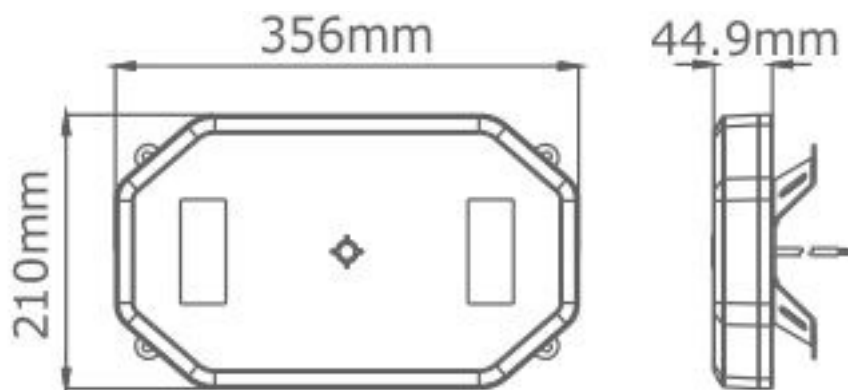

Specification

Type	LED Light Bar
Colour	Amber
Voltage	12/24V
Current	2.55A @ 12VDC
Number of LED's	40
LED Power	40W
Lens	Polycarbonate
Housing	ABS
Weight	1.7Kg
Dimensions	Please see above diagram
IP Rating	IP65
Flash Patterns	19
Compliance	E Marked ECE R65, R10 EMC

The information contained in this document is correct to the best of our knowledge at the time of printing. However, specifications may change at any time without notice.